

2022 厦大杯中学物理比赛

2022 XMUM Cup Physics Competition for Secondary School

Question	Acceptable answers		Question	Acceptable answers
1	4.5		16	3.9
2	12		17	20
3	45		18	12
4	28		19	2.7
5	5.6		20	1.4
6	13		21	0.64
7	600		22	1.2
8	3.8		23	0.49
9	5.7		24	1.5
10	44		25	Cancelled
11	34		26	0.75
12	88		27	1.5
13	29		28	3.7
14	7.8		29	4.5
15	0.84		30	1.5

Topics	Questions	No. Questions
Mechanics	8,9,10,11,12,13,14,15,16,29	10
Thermodynamics	2,3,4,5,6,7,30	7
Electromagnetic	18,19,20,21	4
Circuit	22,23,24,28	4
Modern Physics	25	1
Optics	16	1
Waves	15,17	2
Matter	1	1

Question 1

试估算一个 45 kg 的学生身体含有原子的数量。假设人体主要由水分子组成，而水分子的分子量为 18.0 g mol^{-1} ，每个水分子包含 3 个原子。(已知在标准状态下，一摩尔物质含有 6.0×10^{23} 个分子)。答案以 10^{27} 原子数为单位并保留 2 位有效数字。

Estimate the number of atoms in the body of a 45 kg student. Assume that the human body is mostly water, which has molar mass 18.0 g mol^{-1} , and that each water molecule contains three atoms. (Avogadro's number = 6.0×10^{23} molecules per mole.) **Give the answer in unit of 10^{27} atoms to 2 significant figures.**

Solution:

$$\text{number of moles } n = \frac{45}{18 \times 10^{-3}} = 2.5 \times 10^3 \text{ mol}$$

Each water molecule has 3 atoms, so, total number of atoms for n moles of water is

$$\begin{aligned} N &= 3 \times (2.5 \times 10^3)(6.0 \times 10^{23}) \\ &= 4.5 \times 10^{27} \end{aligned}$$

Answer : 4.5

Question 2

0.250 mole 的理想气体的热容比 $\gamma = 1.40$ ，从平衡态 i 经历绝热膨胀至平衡态 f 。已知气体在状态 i 的体积为 $2.0 \times 10^{-3} \text{ m}^3$ ，在状态 f 的体积和压强分别为 $9.0 \times 10^{-3} \text{ m}^3$ 及 1.5 atm。计算气体在平衡态 i 的压强。答案以 atm 为单位保留至 2 为有效数字。

0.250 mole of an ideal gas with heat capacity ratio $\gamma = 1.40$, expands from an equilibrium state i to another equilibrium state f through an adiabatic process. Given the volume of the gas at state i is $2.0 \times 10^{-3} \text{ m}^3$, the volume and the pressure at state f are $9.0 \times 10^{-3} \text{ m}^3$ and 1.5 atm, respectively. Calculate the pressure of the gas at state i . **Give the answer in unit of atm to 2 significant figures.**

Solution:

For an adiabatic process

$$\begin{aligned} P_i V_i^\gamma &= P_f V_f^\gamma \\ P_i &= 1.46 \left(\frac{0.009}{0.002} \right)^{1.40} \\ &= 12 \text{ atm} \end{aligned}$$

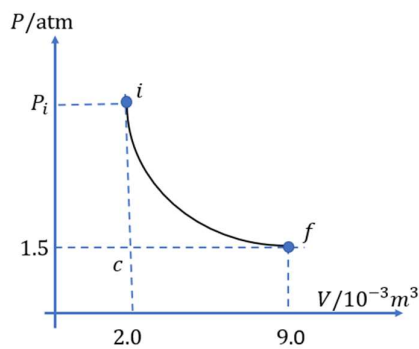

Answer: 12

Confidential

Question 3

计算 81.4 g, $-5.0\text{ }^{\circ}\text{C}$ 的冰块熔解成 $50\text{ }^{\circ}\text{C}$ 的水所需要吸收的热量。答案以 kJ 为单位并保留 2 位有效数字。(已知冰块的比热为 $2050\text{ J kg}^{-1}\text{ K}^{-1}$, 水的比热为 $4184\text{ J kg}^{-1}\text{ K}^{-1}$, 熔化热为 334 kJ kg^{-1})

Calculate the heat absorbed to convert 81.4 g of ice at $-5.0\text{ }^{\circ}\text{C}$ to water at $50\text{ }^{\circ}\text{C}$. **Give the answer in unit of kJ to 2 significant figures.** (Given specific heat of ice $2050\text{ J kg}^{-1}\text{ K}^{-1}$, specific of water $4184\text{ J kg}^{-1}\text{ K}^{-1}$, heat of fusion of water 334 kJ kg^{-1}).

Solution:

$$\begin{aligned}Q_{total} &= Q_{ice} + Q_{ice\ to\ water} + Q_{water} \\&= 81.4 \times (2.05 \times 5 + 334 + 4.184 \times 50) \\&= 45050\text{ J} = 45\text{ kJ}\end{aligned}$$

Answer: 45

Question 4

从 $900\text{ }^{\circ}\text{C}$ 的熔炉中取出一 0.45 kg 的铁块放入 10.0 kg, $24.0\text{ }^{\circ}\text{C}$ 的水中。假设过程中没有热损失, 求铁块与水的平衡温度。(铁块的比热为 $449\text{ J kg}^{-1}\text{ }^{\circ}\text{C}^{-1}$, 水的比热为 $4184\text{ J kg}^{-1}\text{ }^{\circ}\text{C}^{-1}$) 答案以 $^{\circ}\text{C}$ 为单位保留至 2 位有效数字。

A 0.45-kg iron bar is taken from a forge at $900\text{ }^{\circ}\text{C}$ and dropped into 10.0 kg of water at $24.0\text{ }^{\circ}\text{C}$. Assuming no energy is lost as heat to the surroundings as the water and bar reach their final temperature, determine the final temperature of the water-bar system. (Specific heat of iron is $449\text{ J kg}^{-1}\text{ }^{\circ}\text{C}^{-1}$; Specific heat of water is $4184\text{ J kg}^{-1}\text{ }^{\circ}\text{C}^{-1}$). **Give the answer in unit of $^{\circ}\text{C}$ to 2 significant figures.**

Solution: No heat loss

$$\begin{aligned}Q_{iron} + Q_{water} &= 0 \\0.45 \times 449(T_f - 900) + 10 \times 4184(T_f - 24) &= 0 \\T_f &= 28.2\text{ }^{\circ}\text{C}\end{aligned}$$

Answer: 28

Confidential

Question 5

一般上，一个专注听物理课的学生产生热的功率大约是 110 W。假设学生所放出的热完全被教室中的空气所吸收。空气的比热为 $1020 \text{ J kg}^{-1} \text{ K}^{-1}$ ，密度为 1.20 kg m^{-3} 。试估算 25 位学生在 1200 m^3 的教室中专注听课 50 分钟后，教室中空气的温度会上升多少。答案以 K 为单位保留至 2 位有效数字。

A typical student listening attentively to a physics lecture has a heat output of 110 W. Assume that all the heat released by the student is absorbed by the air in the classroom. The air has specific heat $1020 \text{ J kg}^{-1} \text{ K}^{-1}$ and density 1.20 kg m^{-3} . Estimate the rise of temperature of the air in a classroom of volume of 1200 m^3 occupied by 25 attentive students after a 50-min lecture. Give the answer in unit of K to 2 significant figures.

Solution: The total heat release by 25 students in 50 minutes is

$$\Delta Q = N\Delta tP = 25(50 \times 60)(110) = 8.25 \times 10^6 \text{ J}$$

The total mass of the air in the room is

$$m = \rho V = 1.20 \times 1200 = 1440 \text{ kg}$$

So, the temperature raises

$$\Delta T = \frac{\Delta Q}{mc} = \frac{8.25 \times 10^6}{1440 \times 1020} = 5.6 \text{ K}$$

Answer: 5.6

Question 6

一半径为 1.0 cm 的球形气泡自湖面 20 m 深处释放，初始温度为 285 K。已知湖面的温度为 300 K，大气压为 $1.0 \times 10^5 \text{ Pa}$ ，水的密度为 1000 kg m^{-3} ，重力加速度为 9.8 m s^{-2} ，计算气泡到达湖面后的体积。(假设气泡中的气体为理想气体，在上升过程中一直处于热平衡。)答案以 cm^3 为单位保留至 2 位有效数字。

A spherical air bubble of radius 1.0 cm is released 20 m below the surface of a pond at 285 K. Given that the temperature at the surface of the pond is 300 K, atmosphere pressure is $1.0 \times 10^5 \text{ Pa}$, the density of water is 1000 kg m^{-3} , gravitational acceleration is 9.8 m s^{-2} , calculate the volume of the bubble when it reaches the surface of the pond. (Assume that the gas in the bubble is an ideal gas and in thermal equilibrium the whole time.). Give the answer in unit of cm^3 to 2 significant figures.

Solution:

From ideal gas law

$$V_f = V_i \left(\frac{P_i}{P_f} \right) \left(\frac{T_f}{T_i} \right)$$

because

$$P_i = P_0 + \rho gh$$

Confidential

$$P_f = P_0$$

So

$$V_f = \frac{4\pi}{3} (1)^3 \left(\frac{1.0 \times 10^5 + 1000(9.8)(20)}{1.0 \times 10^5} \right) \left(\frac{300}{285} \right) = 13 \text{ cm}^3$$

Answer: 13

Question 7

某理想气体在体积为 4.0 L 的容器中之压强为 1.0×10^5 Pa。求理想气体的平均动能。
答案以 J 为单位保留至 2 位有效数字。

The pressure of an ideal gas inside a container with volume of 4.0 L is 1.0×10^5 Pa. Find the average kinetic energy of the ideal gas. **Give the answer in unit of J to 2 significant figures.**

Solution:

From ideal gas law

$$PV = nRT$$

$$E_k = \frac{3}{2} nRT = \frac{3}{2} 1.0 \times 10^5 \times 4.0 \times 10^{-3} = 600 \text{ J}$$

Question 8

一粒子约束在半径 4.00 m 的圆轨道上以匀加速 4.80 ms^{-2} 增加速率。当粒子的合加速度为 6.00 ms^{-2} 的瞬时，其速率是多少？答案以 ms^{-1} 为单位保留至 2 位有效数字。

The speed of a particle moving in a circle 4.00 m in radius increases at a constant rate of 4.80 ms^{-2} . At the instant when the magnitude of the total acceleration is 6.00 ms^{-2} , what is the speed of the particle? **Give the answer in unit of ms^{-1} to 2 significant figures.**

Solution:

The centripetal acceleration is

$$a_c = \sqrt{a^2 - a_t^2} = \frac{v^2}{r}$$

$$\sqrt{6.0^2 - 4.8^2} = \frac{v^2}{4.0}$$

$$v = 3.8 \text{ ms}^{-1}$$

Answer: 3.8

Confidential

Question 9

A, B 两滑块的质量分别为 $m_A = 0.50 \text{ kg}$ 和 $m_B = 0.30 \text{ kg}$, 以速度 $u_A = 3.7 \text{ ms}^{-1}$ 及 $u_B = -2.0 \text{ ms}^{-1}$ 作弹性正撞。碰撞后瞬间, B 相对 A 的速度是多少? 答案以 ms^{-1} 为单位保留至 2 位有效数字。

Two gliders, A and B with masses $m_A = 0.50 \text{ kg}$, moving at velocity $u_A = 3.7 \text{ ms}^{-1}$, and $m_B = 0.30 \text{ kg}$, moving at velocity $u_B = -2.0 \text{ ms}^{-1}$ collide head on and elastically. What is the velocity of B relative to A after collision? **Give the answer in unit of ms^{-1} to 2 significant figures.**

Solution:

The coefficient of restitution is 1 for elastic collision,

$$\varepsilon = -\frac{v_{BA}}{u_{BA}}$$

$$v_{BA} = -(u_B - u_A) = -(-2.0 - 3.7) = 5.7 \text{ ms}^{-1}$$

Answer: 5.7

Question 10

一小石头从一干涸的井口由静止往下落。石头撞击底部的声音在石头下落后 3.14 s 被听见。假设声音在空气中的速率是个定值 300 ms^{-1} , 重力加速度 9.8 m s^{-2} , 石头受的空气阻力可以忽略。计算井的深度。答案以 m 为单位保留至 2 位有效数字。

A stone is dropped from rest into a dry well. The sound of the stone hitting the bottom is heard 3.14 s after dropped. Assuming the speed of sound in air is constant at 300 ms^{-1} , gravitational acceleration 9.8 m s^{-2} , and air resistance on the stone is negligible. Calculate the depth of the well. **Give the answer in unit of m to 2 significant figures.**

Solution: Let t_1 be the time taken for the stone to fall into the bottom, and t_2 is the time the sound travels from the bottom to the top of the well. H is the depth of the well

$$t_1 + t_2 = T$$

$$\sqrt{\frac{2H}{g}} + \frac{H}{u} = T$$

$$\begin{aligned}\sqrt{H} &= \frac{u}{2} \left[-\sqrt{\frac{2}{g}} + \sqrt{\frac{2}{g} + \frac{4T}{u}} \right] \\ &= \frac{300}{2} \left[-\sqrt{\frac{2}{9.8}} + \sqrt{\frac{2}{9.8} + 4 \frac{3.14}{300}} \right] \\ H &= 43.9 \text{ m}\end{aligned}$$

Answer: 44

Question 11

考虑一只质量为 $3.1 \times 10^{-3} \text{ g}$ 的昆虫以六只脚站在水面上。昆虫的重量均匀的分布在六只脚。假设昆虫的脚底部为半径 $2.0 \times 10^{-5} \text{ m}$ 的球形，如图 2 所示。已知水的表面张力系数为 0.072 Nm^{-1} ，重力加速度 9.8 m s^{-2} 估算表面张力与水平面的夹角 θ 。答案以角度为单位保留至 2 位有效数字。

Consider an insect of mass $3.1 \times 10^{-3} \text{ g}$ standing on water surface with its six legs. The weight of the insect distributes uniformly to the six legs. Assume that the base of the insect's leg is approximately spherical in shape with a radius of $2.0 \times 10^{-5} \text{ m}$, as shown in Fig. 2. Given the surface tension of water is 0.072 Nm^{-1} , gravitational acceleration 9.8 m s^{-2} , estimate the angle θ of the surface tension to the horizontal. **Give the answer in unit of degree to 2 significant figures.**

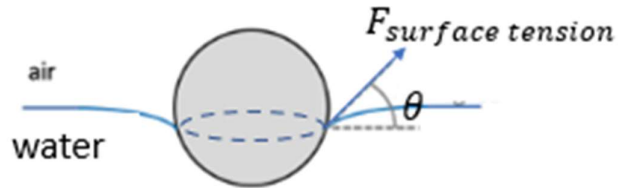

Figure 2

Solution:

$$\begin{aligned}F \sin \theta &= \frac{1}{6} mg \\ \sin \theta &= \frac{1}{6} \frac{mg}{F} = \frac{1}{6} \frac{3.1 \times 10^{-6} \times 9.8}{2\pi \times 10^{-5} \times 0.072} = 0.56 \\ \theta &= 34^\circ\end{aligned}$$

Answer: 34

Confidential

Question 12

Kathy 和 Tommy 站在一重量均匀的平台。平台的重量为 36 N, Kathy 和 Tommy 的重量分别为 400N 及 500N。Kathy 手握着绳索, 透过挂在天花板上的滑轮组将平台平衡在半空中, 如图 3 所示。求 Kathy 对平台施加压力的大小。答案以N为单位保留至 2 位有效数字。

Kathy and Tommy stand on a uniform platform. The platform weighs 36 N. Kathy and Tommy weighs 400 N and 500N, respectively. Kathy is keeping the platform in balance in the air by holding the rope from a set of pulleys which are attached to the ceiling as shown in the Fig. 3. Find the downward force that Kathy exerting on the platform. **Give the answer in unit of N to 2 significant figures.**

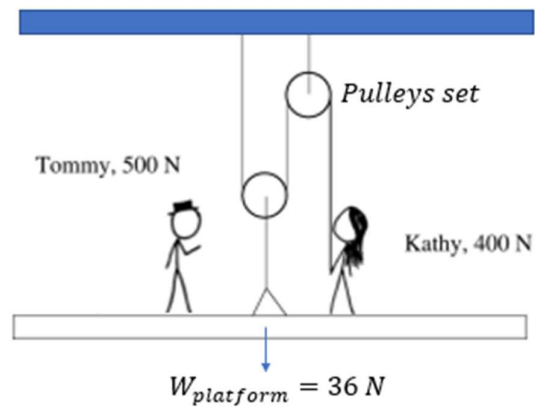
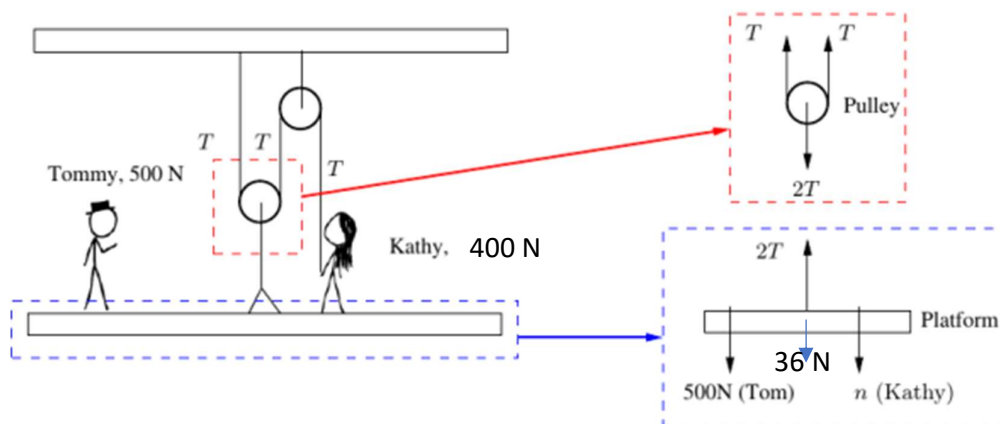

Figure 3

Solution:



$$2T = 500 + 36 + n$$

$$n = 400 - T$$

$$n = 88\text{ N}, \quad T = 312\text{ N}$$

Answer: 88

Confidential

Question 13

一拖车的质量为 $M = 5.00 \text{ kg}$ ，受往右拉的水平张力 T 。在拖车上静置一质量为 $m = 1.00 \text{ kg}$ 的砖块。砖块与拖车之间的静摩擦系数为 $\mu_s = 0.500$ 。若拖车与地面的摩擦力可以不计，重力加速度 9.8 m s^{-2} ，求砖块不会在拖车表面上滑动的最大张力。答案以 N 为单位保留至 2 位有效数字。

A trolley of mass $M = 5.00 \text{ kg}$ is being pulled to right by a horizontal tension T . On top of it sits a block of mass $m = 1.00 \text{ kg}$. The coefficient of static friction between the block and the trolley is $\mu_s = 0.500$. If the friction between the trolley and the ground is negligible, gravitational acceleration 9.8 m s^{-2} , find the maximum tension T so that the block does not slip over the surface of the trolley. **Give the answer in unit of N to 2 significant figures.**

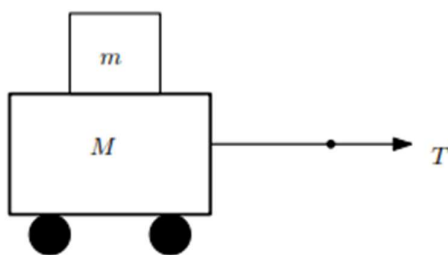

Figure 4

Solution:

$$f_s = ma,$$

$$T - f_s = Ma.$$

$$\begin{aligned} T &= \left(1 + \frac{M}{m}\right) \mu_s mg \\ &= \left(1 + \frac{5.0}{1.0}\right) 0.5 \times 1.0 \times 9.8 = 29.4 \text{ N} \end{aligned}$$

Answer: 29

Confidential

Question 14

一质量为 m 的木块以长 $L = 1.25 \text{ m}$ 的弦悬挂在一钉子上。不考虑任何阻力，要使木块绕钉子，在竖直面上维持圆周运动，其在底部的最小速率应为多少？（重力加速度 9.8 m s^{-2} ）答案以 m s^{-1} 为单位保留至 2 位有效数字。

A block of mass m is suspended freely from a nail with a string of length $L = 1.25 \text{ m}$. Without considering any resistance, what minimum speed of the block at the bottom is required to maintain a circular motion in vertical plane? (Take gravitational acceleration 9.8 m s^{-2}) Give the answer in unit of m s^{-1} to 2 significant figures.

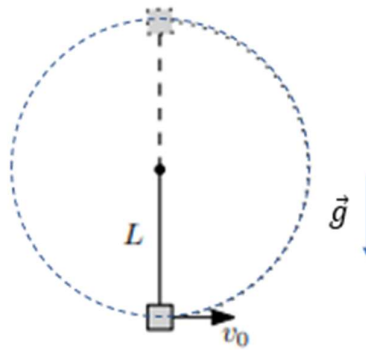

Figure 5

Solution:

By conservation of energy

$$\frac{1}{2}mv_0^2 = \frac{1}{2}mv^2 + mg2L$$

$$v^2 = v_0^2 - 4gL$$

When the block is at the apex,

$$T + mg = m\frac{v^2}{L}$$

For minimum velocity v_0 , $T = 0$

$$Lg = v_0^2 - 4gL$$

$$v_0 = \sqrt{5gL} = \sqrt{5 \times 9.8 \times 1.25} = 7.83 \text{ ms}^{-1}$$

Answer: 7.8

Confidential

Question 15

太空中陨石 A 和陨石 B 具有相同的半径 $R = 32 \text{ m}$ 。陨石 A 的质量为 $M = 7.1 \times 10^5 \text{ Kg}$ ，陨石 B 的质量为 $2M$ 。当两陨石的中心相距 $10R$ 时相对静止，如图 6 所示。两陨石因万有引力相向运动，求在两陨石发生碰撞前一瞬间，系统的总动能。答案以 J 为单位保留至 2 位有效数字。(万有引力常数 $6.67 \times 10^{-11} \text{ Nm}^2 \text{ kg}^{-2}$ 。)

Two spherical asteroids in space have the same radius $R = 32 \text{ m}$. Asteroid A has mass $M = 7.1 \times 10^5 \text{ Kg}$ and Asteroid B has mass $2M$. The two asteroids are relatively at rest when the distance between their centres is $10R$, as shown in Fig.6. The two asteroids move towards each other due to the gravitational force. Find the kinetic energy of the system at the instant just before they collide. Give the answer in unit of J to 2 significant figures. (Gravitational constant $6.67 \times 10^{-11} \text{ Nm}^2 \text{ kg}^{-2}$)

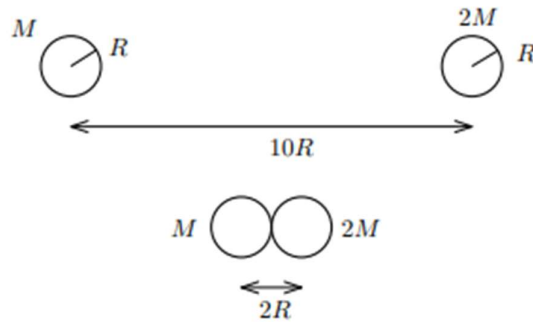

Figure 6

Solution:

Conservation of energy gives

$$-\frac{GM(2M)}{10R} + 0 = -\frac{GM(2M)}{2R} + E_k$$
$$E_k = \frac{4GM^2}{5R} = \frac{4}{5} \times 6.67 \times 10^{-11} \times (7.1 \times 10^5)^2 \frac{1}{32}$$
$$= 0.84 \text{ J}$$

Answer: 0.84

Confidential

Question 16

质量为 800 g 的均匀木棒的下端以无摩擦阻力的铰链系在墙上，木棒的上端以水平的弦拉着使木棒与墙面成 45° 角，如图 7 所示。求沿水平弦的张力。取重力加速度 9.8 m s^{-2} 。答案以 N 为单位保留至 2 位有效数字。

The lower end of a uniform bar of mass 800 g is attached to a wall by a frictionless hinge. The bar is held by a horizontal string at its upper end so that the bar makes an angle of 45° with the wall, as shown in Fig. 7. Find the tension along the string. (Take gravitational acceleration 9.8 m s^{-2}) Give the answer in unit of N to 2 significant figures.

Figure 7

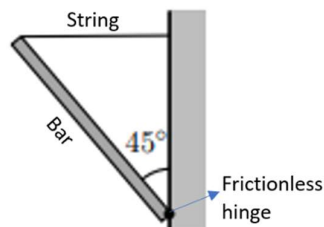

Solution:

From torque balance

$$Mg \frac{L}{2} \sin 45^\circ - F_0 L \cos 45^\circ = 0$$

$$F_0 = \frac{1}{2} Mg \tan 45^\circ = 3.92 \text{ N}$$

Answer: 3.9

Question 17

一辆静止不动的汽车发出频率为 520 Hz 的声波。你正骑着摩多车背离汽车而去。若你听到的声波频率是 490 Hz，你相对汽车的速率是多少？设空气中的声速为 345 m s^{-1} 。答案以 m s^{-1} 为单位保留至 2 位有效数字。

A stationary car is emitting sound waves of frequency 520 Hz. You are on a motorcycle, traveling directly away from the car. What speed must you be traveling if you detect a frequency of 490 Hz? The speed of sound in air is 345 m s^{-1} . Give the answer in unit of m s^{-1} to 2 significant figures.

Solution:

Using Doppler effect

$$f_o = \frac{v + v_o}{v + v_s} f_s$$

$$v_o = v \left(\frac{f_o}{f_s} - 1 \right) = 345 \left(\frac{490}{520} - 1 \right) = -19.9 \text{ m s}^{-1}$$

Answer: 20

Confidential

Question 18

一道自然光以某角度入射水面可使其反射的光变为线偏振光。而其折射光进入水中被一玻璃砖反射后也变为线偏振光。已知水和玻璃砖的折射率分别为 1.33 和 1.53。求玻璃砖面与水面的夹角, θ 。答案以角度为单位保留至 2 位有效数字。

A beam of natural light is incident on a water surface at such an angle that the reflected light is completely linearly polarized. The refracted light travelling in the water turns completely into linearly polarized as well after reflected by the surface of a block of glass. Given that the refractive indices of the water and the glass are 1.33 and 1.53 respectively. Find the angle, θ between the glass and water surfaces. **Give the answer in unit of degree to 2 significant figures.**

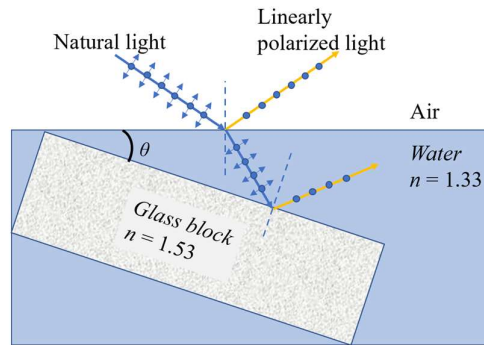

Figure 8

Solution:

The incident angle is the Brewster angle,

$$\tan \theta_B = \frac{n_2}{n_1} = \frac{1.33}{1} \rightarrow \theta_B = 53.06^\circ$$

The angle the refracted ray makes with the normal to the air/water interface is

$$\theta_R = \sin^{-1}\left(\frac{\sin \theta_B}{1.33}\right) = 36.94^\circ$$

The polarizing angle for the water/glass interface is

$$\tan \theta'_B = \frac{1.53}{1.33} \rightarrow \theta'_B = 49.0^\circ$$

Hence, the glass block is tilted from the water surface by $49.0 - 36.94 = 12.06^\circ$

Answer: 12

Confidential

Question 19

一水平狭缝置于一水平平面镜上方 0.10 mm 处。一波长为 542 nm 的单色光经过狭缝之后，在离狭缝 1.0 m 处的屏幕上形成干涉条纹(图 9)。计算在屏幕上干涉亮纹的间距。
答案以 mm 为单位保留至 2 位有效数字。

A narrow, horizontal slit is located 0.10 mm above a horizontal mirror. A monochromatic light with a wavelength of 542 nm passes through the slit and forms an interference pattern on a screen 1.0 m away from the slit(Fig. 9). Calculate the separation between two bright fringes of the interference pattern. **Give the answer in unit of mm to 2 significant figures.**

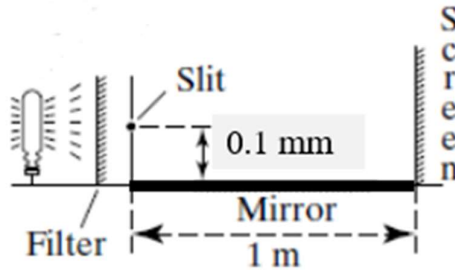

Figure 9

Solution:

The light reflecting off the mirror creates a virtual source which is 0.10 mm into the mirror, form a double slits separation of 0.20 mm. Hence

$$m\lambda = a \frac{y}{L}$$
$$\Delta y = 542 \times 10^{-6} \frac{1000}{0.20} = 2.71 \text{ mm}$$

Answer: 2.7

Question 20

当两个点电荷 $q_1 = 26.0 \mu\text{C}$, $q_2 = -47.0 \mu\text{C}$ 之间静电力的大小为 5.60 N 时, 它们的距离是多少? 取静电常数 $\frac{1}{4\pi\epsilon_0} = 9.0 \times 10^9 \text{ Nm}^2\text{C}^{-2}$ 。答案以 **m** 为单位保留至 **2** 位有效数字。

What must be the distance between point charges $q_1 = 26.0 \mu\text{C}$, $q_2 = -47.0 \mu\text{C}$ for the electrostatic force between them to have a magnitude of 5.60 N ? Take electrostatic constant $\frac{1}{4\pi\epsilon_0} = 9.0 \times 10^9 \text{ Nm}^2\text{C}^{-2}$. **Give the answer in unit of m to 2 significant figures.**

Solution:

$$\begin{aligned} r &= \sqrt{\frac{1}{4\pi\epsilon_0} \frac{q_1 q_2}{F}} \\ &= \sqrt{\frac{(9.0 \times 10^9)(26.0 \times 10^{-6})(47.0 \times 10^{-6})}{5.60}} \\ &= 1.4 \text{ m} \end{aligned}$$

Answer: 1.4

Question 21

一半径为 17.0 cm 的圆环导线置于匀强磁场中。磁场与圆环面垂直, 强度为 0.800 T 。若圆环半径以开始以瞬时速率 75.0 cm s^{-1} 收缩, 求圆环开始收缩瞬间的感应电动势。答案以 **V** 为单位保留至 **2** 位有效数字。

A conducting circular loop of 17.0 cm radius is placed in a uniform magnetic field. The magnetic field has strength 0.800 T and is perpendicular to the plane of the loop. If the radius of the loop starts to shrink at an instantaneous rate of 75.0 cm s^{-1} , find the instantaneous emf induced in the loop at that moment it starts to shrink. **Give the answer in unit of V to 2 significant figures.**

Solution:

Using Faraday's law

$$\begin{aligned} \epsilon &= \frac{d}{dt} \phi_B = B \frac{d}{dt} \pi r^2 \\ &= 2\pi B r \frac{dr}{dt} \\ &= 2\pi(0.80)(0.17)(0.75) \\ &= 0.64 \text{ V} \end{aligned}$$

Answer: 0.64

Confidential

Question 22

图 10 中显示两电荷 $q_1 = -2.80 \times 10^{-19} \text{ C}$ 及 $q_2 = +2.80 \times 10^{-19} \text{ C}$ 分别放置在 x 轴上 -3.00 m 及 $+3.00 \text{ m}$ 处。求在 y 轴上离原点 4.00 m 处的总电场强度大小。答案以 $10^{-10} \text{ N C}^{-1}$ 为单位保留至 2 位有效数字。取静电常数 $\frac{1}{4\pi\epsilon_0} = 9.0 \times 10^9 \text{ Nm}^2\text{C}^{-2}$

Fig. 10 shows two point-charges, $q_1 = -2.80 \times 10^{-19} \text{ C}$ and $q_2 = +2.80 \times 10^{-19} \text{ C}$ on x axis $x = -3.00 \text{ m}$ and $x = +3.00 \text{ m}$. Find the magnitude of the electric field on y axis 4.00 m away from the origin. **Give the answer in unit of $10^{-10} \text{ N C}^{-1}$ to 2 significant figures.**

Take electrostatic constant $\frac{1}{4\pi\epsilon_0} = 9.0 \times 10^9 \text{ Nm}^2\text{C}^{-2}$.

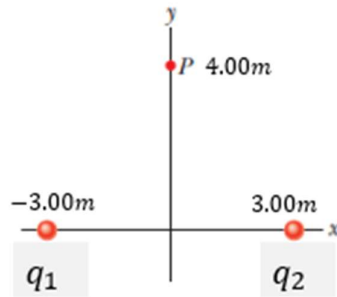

Figure 10

Solution:

$$\begin{aligned} E &= \frac{2q}{4\pi\epsilon_0} \left(\frac{1}{y^2 + d^2} \frac{d}{\sqrt{y^2 + d^2}} \right) \\ &= 9.0 \times 10^9 \frac{2(2.80 \times 10^{-19})(3.00)}{(4.0^2 + 3.0^2)^{\frac{3}{2}}} \\ &= 1.21 \times 10^{-10} \text{ N C}^{-1} \end{aligned}$$

Answer: 1.2

Confidential

Question 23

— 13.0-g 导线长 $L = 62.0$ cm, 水平悬挂于一对弹簧绳上 如图 11 所示。一强度为 0.42 T 的均匀磁场指入纸面。求导线承载多大的电流时弹簧绳的张力会是零。取重力加速度为 9.8 ms^{-2} 。答案以 A 为单位保留至 2 位有效数字。

A 13.0-g wire of length $L = 62.0$ cm is suspended horizontally by a pair of flexible ropes as shown in the Fig.11. A uniform magnetic field of magnitude 0.42 T points into the plane. Find the magnitude of the current required to remove tension on the ropes. Take gravitational acceleration as 9.8 ms^{-2} . **Give the answer in unit of A to 2 significant figures.**

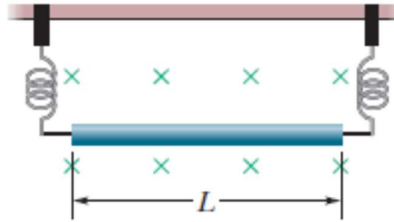

Figure 11.

Solution: The magnetic force on the wire must be upward and have a magnitude equal to the gravitational force mg on the wire. Since the field and the current are perpendicular to each other,

$$\begin{aligned}iLB &= mg \\i &= \frac{mg}{LB} = \frac{(0.013)(9.8)}{(0.62)(0.42)} \\&= 0.49 \text{ A}\end{aligned}$$

Answer: 0.49

Question 24

计算图 12 中总电流 I 的数值。答案以 A 为单位保留至 2 位有效数字。

Calculate the current I that is flowing in the circuit shown in the Fig.12. Give the answer in unit of A to 2 significant figures.

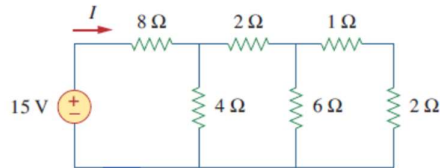

Figure 12

Solution:

$$\begin{aligned}
 R_{eq} &= 8 + 4 \parallel (2 + 6 \parallel 3) \\
 &= 10 \Omega \\
 I &= \frac{15}{R_{eq}} = 1.5 A
 \end{aligned}$$

Answer: 1.5

Question 26

图 14 中电路的开关 S 在时间 $t = 0$ 时闭合，电动势为 5 V 的电池开始给电容值为 $C = 60.0 \mu\text{F}$ 的电容充电。若电路中的电阻值 $R = 20.0 \Omega$ ，求电容充满电后储存的能量。答案以 10^{-3}J 为单位保留至 2 位有效数字。

Switch S in the Fig. 14 is closed at time $t = 0$, a battery with emf = 5V begins to charge an capacitor of capacitance $C = 60.0 \mu\text{F}$. If the resistance $R = 20.0 \Omega$. Find the energy stored in the capacitor after fully charged. Give the answer in unit of 10^{-3}J to 2 significant figures.

Solution:

$$\begin{aligned}
 E &= \frac{1}{2} CV^2 = \frac{1}{2} (60 \times 10^{-6})(5^2) \\
 &= 0.75 \times 10^{-3}\text{J}
 \end{aligned}$$

Answer: 0.75

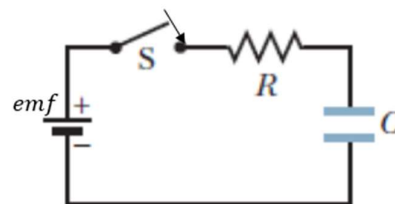

Question 27

海森堡不确定原理表明微观粒子位置与动量的不确定性需满足以下不等式

$$\Delta x \Delta p \geq \frac{h}{4\pi}$$

其中 Δx 和 Δp 分别为位置及动量的不确定性， h 为普朗克常数。

在 β 衰变中，原子核会释放出一个电子和反中微子，物理学家曾假设原子核中带有电子来解释 β 衰变。若电子在原子核中的平均动量为零，其位置的不确定性 Δx 约的等于原子核的大小 10^{-15}m 。试以海森堡不确定原理估算电子的最小平均动能。(电子质量为 $9.1 \times 10^{-31}\text{ kg}$ ，普朗克常数为 $6.6 \times 10^{-34}\text{ Js}$) 答案以 10^{-9} J 为单位保留至2位有效数字。

Heisenberg uncertainty principle states that the uncertainties of the position and momentum of a microscopic particle satisfies inequality,

$$\Delta x \Delta p \geq \frac{h}{4\pi}$$

Where Δx and Δp are the uncertainties of position and momentum, respectively, h is Planck constant. In a β -decay, an electron and an anti-neutrino are released. Physicists have built models of electrons inside a nucleus to explain β -decay. Assume that the average momentum of an electron is zero in a nucleus and the uncertainty of the electron, Δx is about the nucleus size 10^{-15}m . Use Heisenberg uncertainty relation to lower bound mean kinetic energy of an electron inside a nucleus. (Electron mass = $9.1 \times 10^{-31}\text{ kg}$, Planck constant = $6.6 \times 10^{-34}\text{ Js}$) **Give the answer in unit of 10^{-9}J to 2 significant figures.**

Solution:

Mean kinetic energy is given by $T = \frac{\langle p^2 \rangle}{2m}$, where brackets denote the mean. Since mean momentum vanishes, we express the momentum variance as $(\Delta p)^2 = \langle p^2 \rangle - \langle p \rangle^2 = \langle p^2 \rangle$. The mean kinetic energy is therefore proportional to the variance: $K = \frac{(\Delta p)^2}{2m}$. Using the uncertainty relation $\Delta x \Delta p \geq \hbar/2$ we obtain the required lower bound $K \geq \frac{\hbar^2}{8 m (\Delta x)^2}$. The kinetic energy of a hypothetical electron inside the nucleus is therefore at least $\frac{\hbar^2}{8 m \Delta x^2} = \frac{1.113 \times 10^{-68}}{8 \times 9.109 \times 10^{-31} \times 10^{-30}} = 1.5 \times 10^{-9}\text{ J}$.

Answer: 1.5

问题 28 至 30 为虚拟实验题, 参赛者须通过以外部链接进入虚拟实验室。在虚拟实验室中, 按照题目的要求获取相关数据以求得正确答案。最后再回到此页, 将答案填入对应的空格中。

Questions 28 to 30 are virtual experimental questions. Participants must enter the virtual laboratory through an external link. In the virtual laboratory, obtain the relevant data according to the requirements of the question and use the data to calculate the correct answer. Finally, return to this page and fill the answers in the corresponding box.

Confidential

Question 28

Objective: Find internal resistance of a battery. **Give the answer in unit of Ω to 2 significant figures.**

According to Ohm's law, the potential difference, V across a resistor is proportional to the current, I that flows through the resistor. The proportional constant is the resistance, R of the resistor.

$$V = IR$$

In this experiment, a rheostat is connected to a battery with an internal resistance, r . The objective of the experiment is to find the value of the internal resistance by measuring the values of current and voltage for different values of external resistance.

In this virtual laboratory, you can,

1. use mouse right button to rotate the angle of view or switch the scenes between table and lab by clicking the button "Show Table" or "Show Lab".
2. show or hide equipment labels by clicking the button "Show Labels" or "Hide Labels".
3. use mouse left button to drag the two wires (red and blue) of voltmeter to the positions that you want to measure the voltage.
4. turn on or off the battery by clicking the button on the battery.
5. turn on or off the voltmeter by clicking the button on the voltmeter.
6. adjust the value of rheostat by dragging the sliding bar at the right panel.

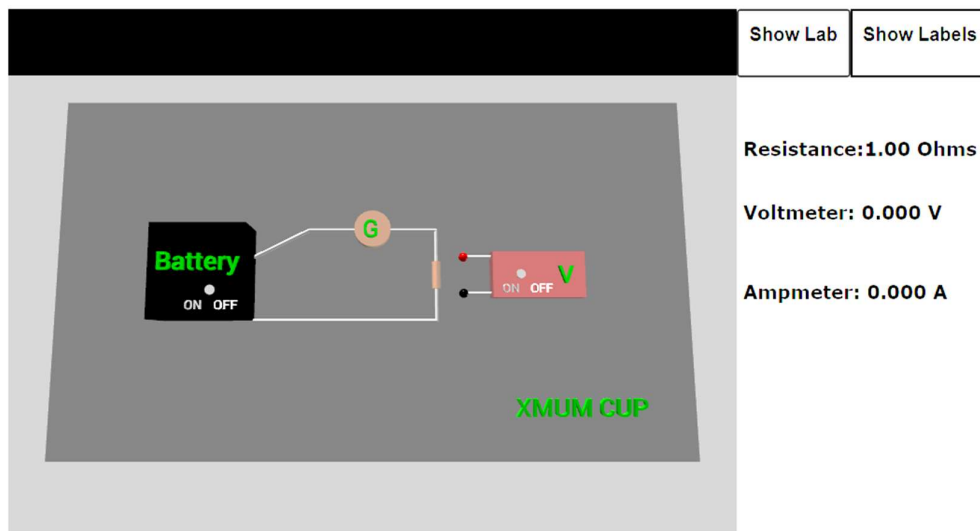

Confidential

实验目的: 求电池的内电阻。答案以 Ω 为单位保留至 2 位有效数字。

根据欧姆定律，电阻器两端的电位差 V 正比于流过电阻器的电流 I ，比例常数即为电阻器的电阻值 R 。

$$V = IR$$

在此实验中，一可变电阻与一个具有内电阻 r 的电池相连接。实验目的是通过测量不同外电阻值的电流与电压来推算电池的内电阻。

在这虚拟实验室中，你可以

1. 使用滑鼠右键旋转视角或点击按键“Show Table”或“Show Lab”来切换桌面和实验室的场景。
2. 点击按键“Show Labels”或“Hide Labels”来显示或隐藏仪器的标签。
3. 使用滑鼠左键拖曳电压计的两条导线(红和蓝)至你要测量电压的位置。
4. 点击电池上的按钮来启动电池。
5. 点击电压计上的按钮来启动电压计。
6. 拖曳右边控制面的滑块来调整变阻器的数值。

Solution:

$$emf = V_R + Ir$$

$$V_R = emf - Ir$$

The potential difference across the external resistance, V_R is linearly proportional to current, I with the internal resistance, r as the slope. By measuring two sets of data (I_1, V_1) , (I_2, V_2) , we can calculate the internal resistance.

$$r = \left| \frac{V_2 - V_1}{I_2 - I_1} \right|$$

Ans: 3.7

Confidential

Question 29

Objective: Find launching speed of a projectile. **Give the answer in unit of ms^{-1} to 2 significant figures.**

If the air resistance is negligible, we can obtain the launching speed, v_0 and angle of a projectile, θ by measuring the trajectory of the projectile.

$$y - y_0 = \tan \theta (x - x_0) - \frac{1}{2} \frac{g}{v_0^2 \cos^2 \theta} (x - x_0)^2$$

Where $g = 9.80 \text{ m s}^{-2}$.

In this experiment, you are given a projectile launcher and a height detector which is movable along a horizontal rail. The angle of the launcher is adjustable, but the launching speed is always fixed. The mission of this question is to find the launching speed from the information of the projectile's initial and final positions.

In this virtual laboratory, you can,

1. move the height detector by dragging the sliding bar at right panel.
2. increase the launcher angle by clicking the button "Increase angle" or press key "q".
3. decrease the launcher angle by clicking the button "Decrease angle" or press key "e".
4. launch the projectile by clicking the button "Launch" or press key "f".
5. reload the projectile by clicking the button "Reload" or press key "r".

The initial and final position will be shown after the projectile was launched

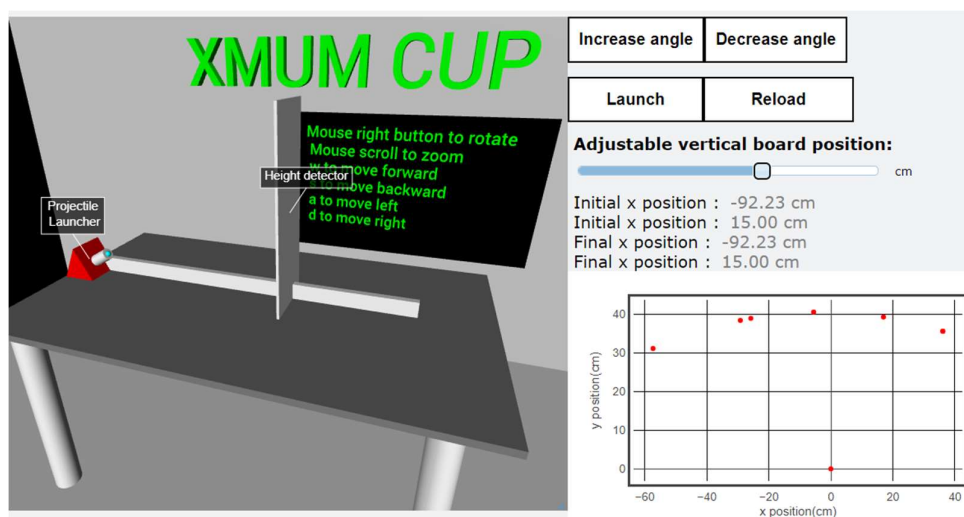

Confidential

实验目的: 求抛射体的发射速率。答案以 ms^{-1} 为单位保留至 2 位有效数字。

若空气阻力可以忽略, 我们可以通过测量抛射体的轨迹来获得发射速率 v_0 与角度 θ 。

$$y - y_0 = \tan \theta (x - x_0) - \frac{1}{2} \frac{g}{v_0^2 \cos^2 \theta} (x - x_0)^2$$

其中 $g = 9.80 \text{ m s}^{-2}$ 。

在此实验中, 你将给予一个抛射体发射器和一个可以水平移动的高度侦测器。发射器的角度可以调整, 但发射体的发射速度大小是固定的。这个问题的任务是通过读取抛射体的初始与末位置来求出抛射体的发射速率。

在这虚拟实验室中, 你可以

1. 拖曳右边的滑块来移动高度侦测器的位置。
 2. 点击按键 “Increase angle” 或 按下键盘 “q” 来增加发射器的角度。
 3. 点击按键 “Decrease angle” 或 按下键盘 “e” 来减小发射器的角度。
 4. 点击按键 “Launch” 或 按下键盘 “f” 来发射抛射体。
 5. 点击按键 “Reload” 或 按下键盘 “r” 来重装发射体。
- 抛射体的初始位置与末位置会在发射后显示。

Solution:

Select a suitable launching angle, θ , then measure two positions of the trajectory (x_1, y_1) , (x_2, y_2) . We can calculate the fixed θ from the two simultaneous equations,

$$(y_1 - y_0) - \tan \theta (x_1 - x_0) = -\frac{1}{2} \frac{g}{v_0^2 \cos^2 \theta} (x_1 - x_0)^2$$
$$(y_2 - y_0) - \tan \theta (x_2 - x_0) = -\frac{1}{2} \frac{g}{v_0^2 \cos^2 \theta} (x_2 - x_0)^2$$

Let $X_1 \equiv x_1 - x_0$, $Y_1 \equiv y_1 - y_0$, $X_2 \equiv x_2 - x_0$, $Y_2 \equiv y_2 - y_0$

Divide two equations

$$\frac{Y_1 - X_1 \tan \theta}{Y_2 - X_2 \tan \theta} = \frac{X_1^2}{X_2^2}$$
$$\tan \theta = \frac{\frac{X_1^2}{X_2^2} Y_2 - Y_1}{\frac{X_1^2}{X_2^2} X_2 - X_1}$$

Then the launching speed can be calculated from

$$v_0^2 = \frac{1}{2} \frac{g}{\cos^2 \theta} \frac{X_1^2}{X_1 \tan \theta - Y_1}$$

Ans: 4.5

Confidential

Question 30

Objective: Find coefficient of linear expansion of an unknown metallic rod. **Give the answer in unit of $10^{-5} \text{ }^\circ\text{C}^{-1}$ to 2 significant figures.**

In this experiment, you are given an unknown metallic rod covered by an insulating tube. The tube is connected to a steam heater which is used to heat up the rod uniformly inside the tube. One end of the metallic rod is fixed and the other end is connected to a dial gauge. When the rod is under thermal expansion, the axle of dial gauge will be pushed and rotate in an angle, θ . The angle in unit of radian multiplies the radius of the gauge's axle, which is $r = 1.50 \text{ mm}$, will give the linear expansion of the rod, $\Delta L = r\theta$

If the length of the rod at temperature $23.0 \text{ }^\circ\text{C}$ is 50.0 cm , try to determine the linear expansion coefficient of the rod from this experiment.

In this virtual laboratory, you can

1. show or hide the labels by clicking the button "Show Labels" or "Hide Labels".
2. turn on or off the heater by clicking the button "Heater On" or "Heater Off".
3. calibrate the dial gauge by clicking the button "Zero".
4. read the temperature of in the tube from the thermometer.
5. read the angle from the dial gauge.

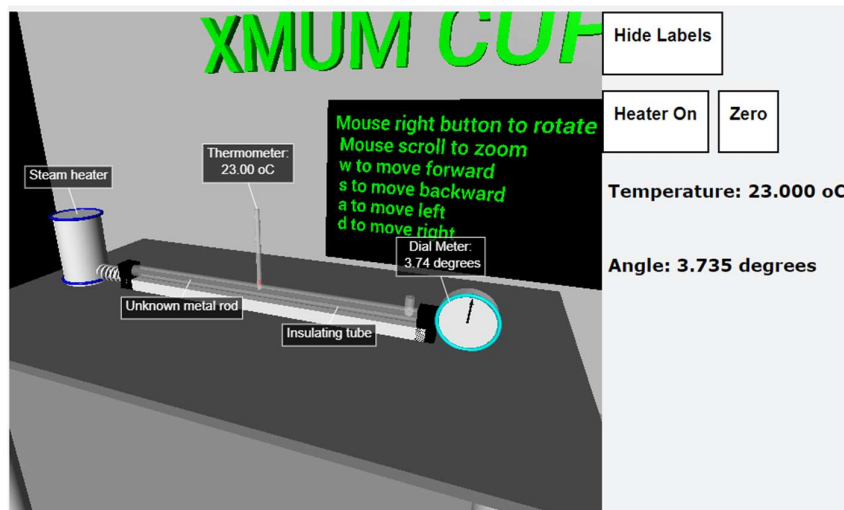

Confidential

实验目的：求未知金属棒的线膨胀系数。答案以 $10^{-5} \text{ } ^\circ\text{C}^{-1}$ 为单位保留至 2 位有效数字。

在此实验中，一条未知金属棒置于一绝热管中。此管与一蒸汽加热器联通，蒸汽可以均匀加热管中的金属棒。金属棒的一端被固定，另一端则接到伸缩规。当金属管受热膨胀时，伸缩规的轴会被推挤而转动指针 θ 角度。以弧度为单位的角度 θ 乘上轴半径 $r = 1.50 \text{ mm}$ ，就能得知金属管的线膨胀量 $\Delta L = r\theta$ 。

已知在室温 $23.0 \text{ } ^\circ\text{C}$ 时，金属棒的长度是 50.0 cm ，试从实验得出金属棒的线膨胀系数。

在这虚拟实验室中，你可以

1. 点击按键“Show Labels”或“Hide Labels”来显示或隐藏仪器的标签。
2. 点击按键“Heater On”或“Heater Off”来启动蒸汽加热器。
3. 点击按键“Zero”来校正伸缩规的读数。
4. 从温度计读取绝热管中的温度。
5. 从伸缩规读取指针旋转的角度。

Solution:

1. Calibrate the dial gauge to zero.
2. Record the initial temperature and length of the rod, (T_0, L_0)
3. Turn on the steam heater. Wait until the temperature reaches an equilibrium temperature T ,
4. Record the angle, θ read by the dial gauge.
5. Then, the coefficient of linear expansion will be

$$\alpha = \frac{r\theta}{L_0(T - T_0)}$$

Ans: 1.5

***** End of Paper *****

**** 试卷结束 ****